

DESIGN FLOOR · LVT 55



JAB
ANSTOETZ
FLOORING

BY

BELAKOS
FLOORING

Overzicht HOUT decors



J-50001
Forest Mix Nature

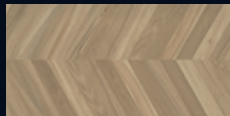

J-50002
Forest Mix Creme

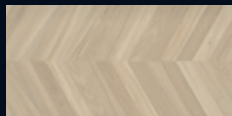

J-50003
Forest Mix Grey



J-50004
Blocked Wood White



J-50005
Blocked Wood Grey



J-50006 Dolden Oak Creme



J-50007 Dolden Oak Nature



J-50008 Dolden Oak Brown

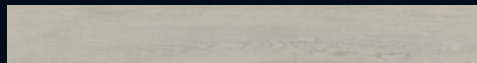

J-50009 Swedish Oak Grey



J-50010 Modern Pine



J-50011 Swedish Oak Dark

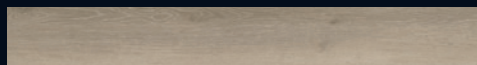

J-50012 Salt Oak

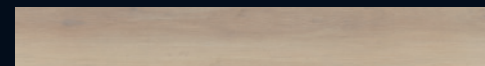

J-50013 Swedish Oak Dark

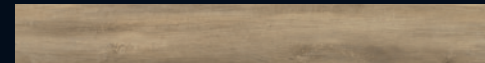

J-50014 Sondrio Oak Nature



J-50015 Cinnamon Oak

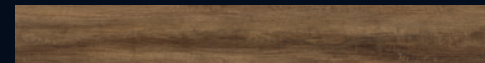

J-50016 Sondrio Oak Red



J-50017 Nugat Oak



J-50018 Pepper Oak

Overzicht STEEN decors



J-50019
Carrara Marble White



J-50022
Used Concrete Grey

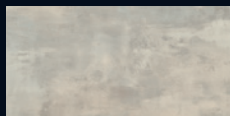

J-50024
Painted Concrete Pastell

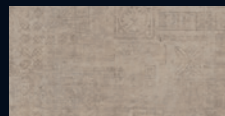

J-50027
Florence Camel

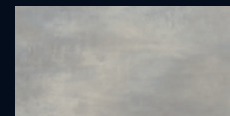

J-50030
Essence Stone

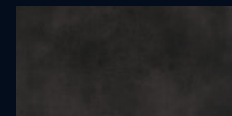

J-50031
Black Stone



J-50020
Brazilian Graphite

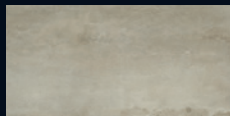

J-50023
Used Concrete Creme

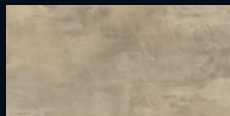

J-50025
Painted Concrete Creme

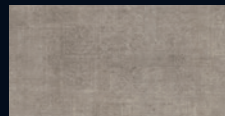

J-50028
Florence Kitt

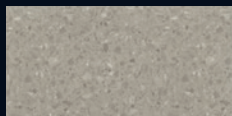

J-50021
Italian Terrazzo



J-50026
Travertine Nude

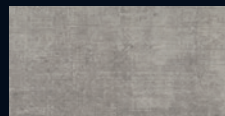

J-50029
Florence Grey

JAB
ANSTOETZ
FLOORING

BY

BELAKOS
FLOORING

Daarom kiest u voor DESIGN FLOOR LVT 55

De DESIGN FLOOR LVT 55 collectie van JAB ANSTOETZ onderscheidt zich door de verfijnde en moderne designs, de verschillende legmogelijkheden en de hoogwaardige kwaliteit.

Door de duurzame en waterbestendige eigenschappen van deze veelzijdige vloeren, zijn ze geschikt voor elke leefruimte. Ze zijn slijtvast en onderhoudsvriendelijk. Daarnaast dragen ze bij aan een gezonde leefomgeving en zijn ze 100% ftalaatvrij.

Verder zijn ze ideaal te combineren met tapijten uit de Belakos tapijtcollectie.

DESIGN FLOOR LVT 55 vloeren zijn zowel in DRY BACK als in Rigid Click+ variant verkrijgbaar in 31 nieuwe designs.

De nieuwe Rigid Click+ variant is een innovatie op het gebied van de hedendaagse, moderne klikvloeren. Door de hoge stabiliteit en de click+ technologie is deze vloer snel en eenvoudig te leggen.

Andere voordelen van de Rigid Click+ zijn:

- Makkelijk over bestaande vloeren te leggen
- Geïntegreerde ondervloer voor een geluidsverbetering tot 20 dB



DRY BACK

DRY BACK LVT heeft een totale dikte van slechts 2,5 mm en is daarom de perfecte vloer voor zowel consumenten-gebruik (ook voor in de badkamer) als projectgebruik.



Rigid Click+

De Rigid Click+ vloeren zijn ideaal wanneer de bestaande vloer intact moet blijven, zoals bijvoorbeeld in huurwoningen.

Door de geïntegreerde (akoestische) ondervloer en stabiele kern kan deze vloer eenvoudig en snel gelegd worden – zelfs over kleine oneffenheden – zonder lijm en extra ondervloer.

DRY BACK 0,55 mm



Rigid Click+ 0,55 mm

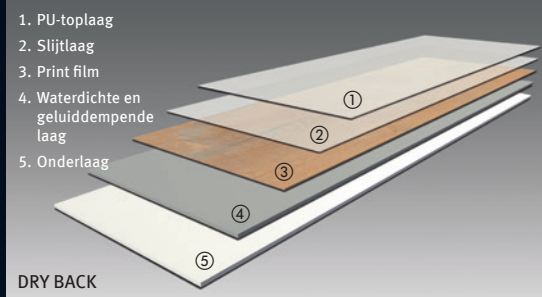

DRY BACK

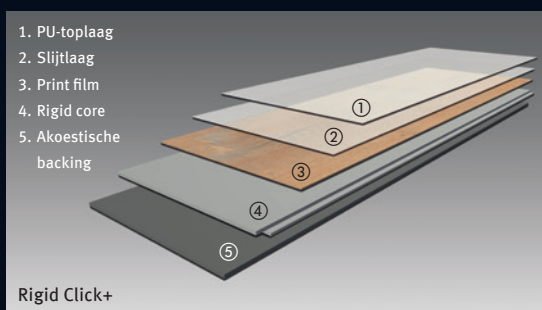

Rigid Click+

Voorbeelden van verschillende legvarianten



Ladderpatroon



Halfsteenverband

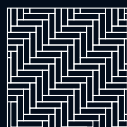

Visgraat*



Dubbele visgraat*



Blokverband



Andere legvarianten

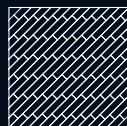

Diagonaal

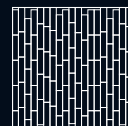

Wildverband

* Niet verkrijgbaar in Rigid Click+



J-50002 Forest Mix Creme

J-50001 Forest Mix Nature



Toepassingsgebieden: 23 / 33 / 42
Toplaag: 0,55 mm
Totaal dikte: 2,5 mm
Formaat: 90,60 × 45,72 cm
Pakinhoud: 8 Planken = 3,31 m²

Afbeelding
complete plank



DRY BACK 0,55 mm



J-50002 Forest Mix Creme

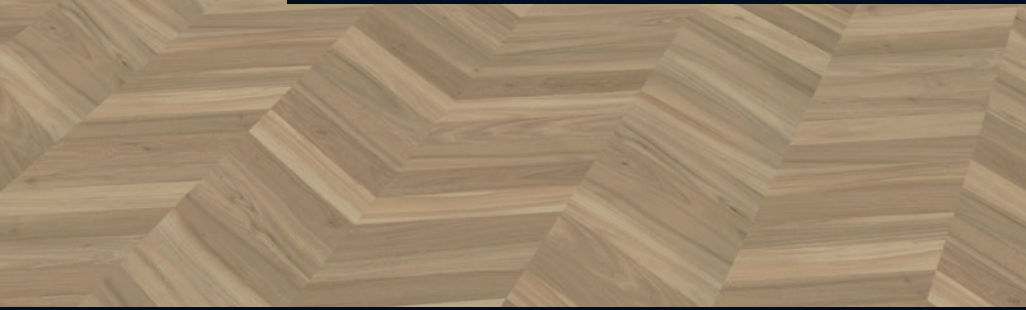

Toepassingsgebieden: 23 / 33 / 42
Toplaag: 0,55 mm
Totaal dikte: 2,5 mm
Formaat: 90,60 × 45,72 cm
Pakinhoud: 8 Planken = 3,31 m²

Afbeelding
complete plank



J-50003 Forest Mix Grey



Toepassingsgebieden: 23 / 33 / 42
Toplaag: 0,55 mm
Totaal dikte: 2,5 mm
Formaat: 90,60 × 45,72 cm
Pakinhoud: 8 Planken = 3,31 m²

Afbeelding
complete plank



COFFEE	2.8
MOCCA	2.5
CAPPUCCINO	3.5
ESPRESSO	3
MACCHIATO	4.2
CHAI	3.5



J-50005 Blocked Wood Grey

J-50004 / J-RCL50004 Blocked Wood White



Toepassingsgebieden: 23 / 33 / 42
Toplaag: 0,55 mm
Totaal dikte: 2,5 mm
Formaat: 91,44 × 45,72 cm
Pakinhoud: 8 Planken = 3,34 m²



Toepassingsgebieden: 23 / 34
Toplaag: 0,55 mm
Totaal dikte: 5,5 mm
Formaat: 90,00 × 45,00 cm
Pakinhoud: 5 Planken = 2,03 m²

J-50005 / J-RCL50005 Blocked Wood Grey



Toepassingsgebieden: 23 / 33 / 42
Toplaag: 0,55 mm
Totaal dikte: 2,5 mm
Formaat: 91,44 × 45,72 cm
Pakinhoud: 8 Planken = 3,34 m²



Toepassingsgebieden: 23 / 34
Toplaag: 0,55 mm
Totaal dikte: 5,5 mm
Formaat: 90,00 × 45,00 cm
Pakinhoud: 5 Planken = 2,03 m²



J-50006 / J-RCL50006 Dolden Oak Creme



Toepassingsgebieden: 23 / 33 / 42
Toplaag: 0,55 mm
Totaal dikte: 2,5 mm
Formaat: 60,96 × 15,24 cm
Pakinhoud: 36 Planken = 3,34 m²



Toepassingsgebieden: 23 / 34
Toplaag: 0,55 mm
Totaal dikte: 5,5 mm
Formaat: 60,00 × 15,00 cm
Pakinhoud: 10 Planken = 0,90 m²

DRY BACK 0,55 mm



Rigid Click+ 0,55 mm



J-50007 / J-RCL50007 Dolden Oak Nature

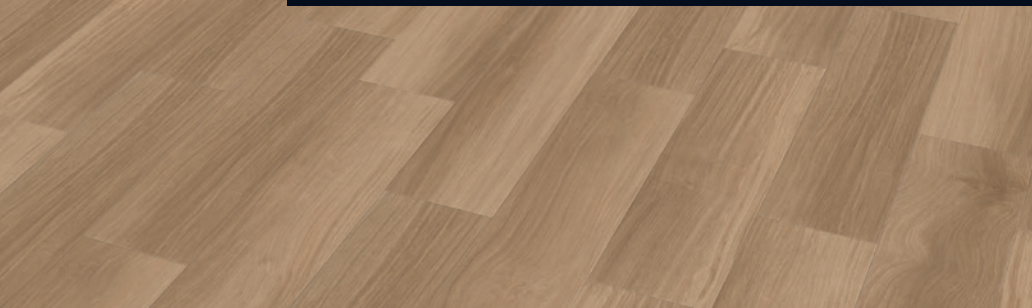

Toepassingsgebieden: 23 / 33 / 42
Toplaag: 0,55 mm
Totaal dikte: 2,5 mm
Formaat: 60,96 × 15,24 cm
Pakinhoud: 36 Planken = 3,34 m²



Toepassingsgebieden: 23 / 34
Toplaag: 0,55 mm
Totaal dikte: 5,5 mm
Formaat: 60,00 × 15,00 cm
Pakinhoud: 10 Planken = 0,90 m²

J-50008 / J-RCL50008 Dolden Oak Brown



Toepassingsgebieden: 23 / 33 / 42
Toplaag: 0,55 mm
Totaal dikte: 2,5 mm
Formaat: 60,96 × 15,24 cm
Pakinhoud: 36 Planken = 3,34 m²



Toepassingsgebieden: 23 / 34
Toplaag: 0,55 mm
Totaal dikte: 5,5 mm
Formaat: 60,00 × 15,00 cm
Pakinhoud: 10 Planken = 0,90 m²

J-50009 / J-RCL50009 Swedish Oak Grey



Toepassingsgebieden: 23 / 33 / 42
Toplaag: 0,55 mm
Totaal dikte: 2,5 mm
Formaat: 152,4 × 22,86 cm
Pakinhoud: 10 Planken = 3,48 m²



Toepassingsgebieden: 23 / 34
Toplaag: 0,55 mm
Totaal dikte: 5,5 mm
Formaat: 150,00 × 22,00 cm
Pakinhoud: 6 Planken = 1,98 m²

J-50010 / J-RCL50010 Modern Pine

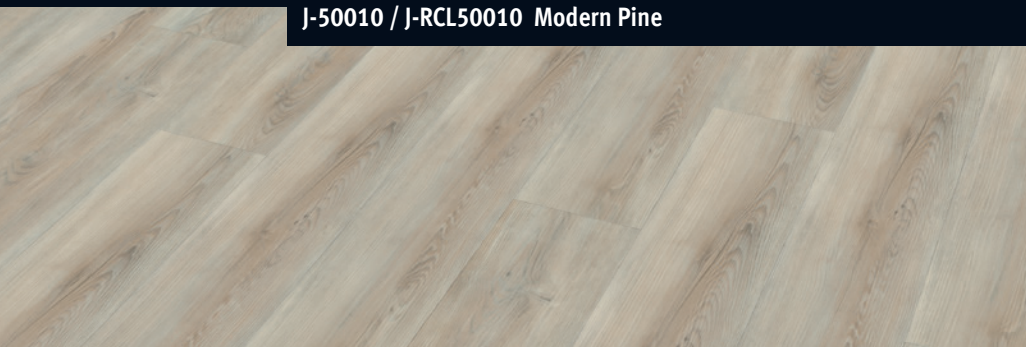

Toepassingsgebieden: 23 / 33 / 42
Toplaag: 0,55 mm
Totaal dikte: 2,5 mm
Formaat: 121,92 × 17,78 cm
Pakinhoud: 16 Planken = 3,46 m²



Toepassingsgebieden: 23 / 34
Toplaag: 0,55 mm
Totaal dikte: 5,5 mm
Formaat: 121,00 × 17,20 cm
Pakinhoud: 10 Planken = 2,08 m²

J-50011 / J-RCL50011 Swedish Oak Dark



Toepassingsgebieden: 23 / 33 / 42
Toplaag: 0,55 mm
Totaal dikte: 2,5 mm
Formaat: 152,4 × 22,86 cm
Pakinhoud: 10 Planken = 3,48 m²



Toepassingsgebieden: 23 / 34
Toplaag: 0,55 mm
Totaal dikte: 5,5 mm
Formaat: 150,00 × 22,00 cm
Pakinhoud: 6 Planken = 1,98 m²

J-50012 / J-RCL50012 Salt Oak

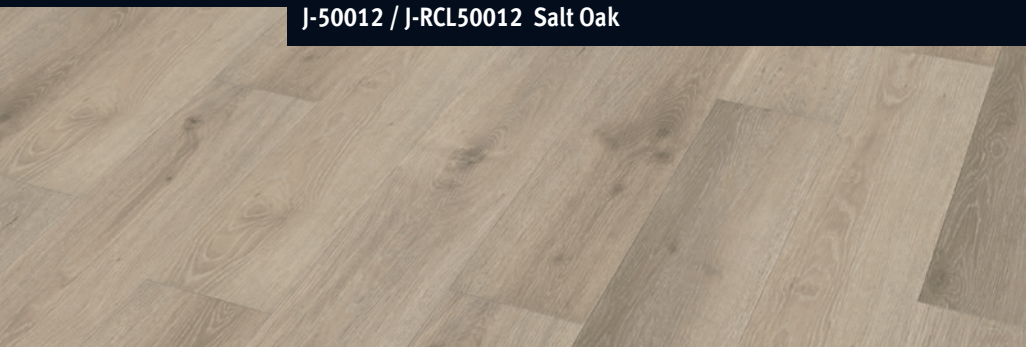

Toepassingsgebieden: 23 / 33 / 42
Toplaag: 0,55 mm
Totaal dikte: 2,5 mm
Formaat: 121,92 × 17,78 cm
Pakinhoud: 16 Planken = 3,46 m²



Toepassingsgebieden: 23 / 34
Toplaag: 0,55 mm
Totaal dikte: 5,5 mm
Formaat: 121,00 × 17,20 cm
Pakinhoud: 10 Planken = 2,08 m²



J-50013 Swedish Oak Oiled

J-50013 / J-RCL50013 Swedish Oak Oiled



Toepassingsgebieden: 23 / 33 / 42
 Toplaag: 0,55 mm
 Totaal dikte: 2,5 mm
 Formaat: 152,4 × 22,86 cm
 Pakinhoud: 10 Planken = 3,48 m²



Toepassingsgebieden: 23 / 34
 Toplaag: 0,55 mm
 Totaal dikte: 5,5 mm
 Formaat: 150,00 × 22,00 cm
 Pakinhoud: 6 Planken = 1,98 m²

J-50014 / J-RCL50014 Sondrio Oak Nature

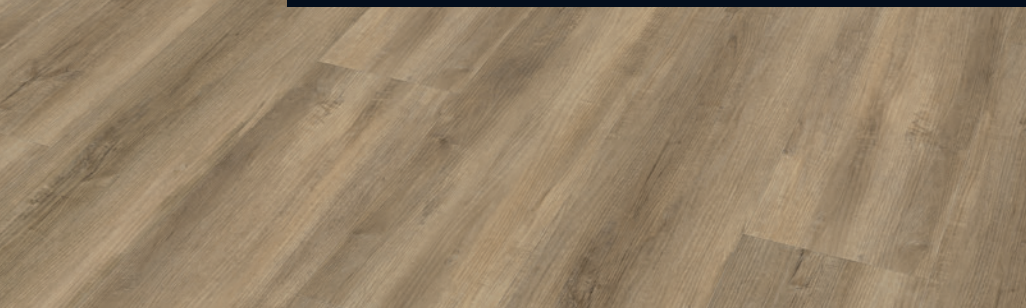

Toepassingsgebieden: 23 / 33 / 42
 Toplaag: 0,55 mm
 Totaal dikte: 2,5 mm
 Formaat: 152,4 × 22,86 cm
 Pakinhoud: 10 Planken = 3,48 m²



Toepassingsgebieden: 23 / 34
 Toplaag: 0,55 mm
 Totaal dikte: 5,5 mm
 Formaat: 150,00 × 22,00 cm
 Pakinhoud: 6 Planken = 1,98 m²

J-50015 / J-RCL50015 Cinnamon Oak



Toepassingsgebieden: 23 / 33 / 42
Toplaag: 0,55 mm
Totaal dikte: 2,5 mm
Formaat: 121,92 × 17,78 cm
Pakinhoud: 16 Planken = 3,46 m²



Toepassingsgebieden: 23 / 34
Toplaag: 0,55 mm
Totaal dikte: 5,5 mm
Formaat: 121,00 × 17,20 cm
Pakinhoud: 10 Planken = 2,08 m²

J-50016 / J-RCL50016 Sondrio Oak Red



Toepassingsgebieden: 23 / 33 / 42
Toplaag: 0,55 mm
Totaal dikte: 2,5 mm
Formaat: 152,4 × 22,86 cm
Pakinhoud: 10 Planken = 3,48 m²



Toepassingsgebieden: 23 / 34
Toplaag: 0,55 mm
Totaal dikte: 5,5 mm
Formaat: 150,00 × 22,00 cm
Pakinhoud: 6 Planken = 1,98 m²

J-50017 / J-RCL50017 Nugat Oak



Toepassingsgebieden: 23 / 33 / 42
Toplaag: 0,55 mm
Totaal dikte: 2,5 mm
Formaat: 152,4 × 22,86 cm
Pakinhoud: 10 Planken = 3,48 m²



Toepassingsgebieden: 23 / 34
Toplaag: 0,55 mm
Totaal dikte: 5,5 mm
Formaat: 150,00 × 22,00 cm
Pakinhoud: 6 Planken = 1,98 m²

J-50018 / J-RCL50018 Pepper Oak

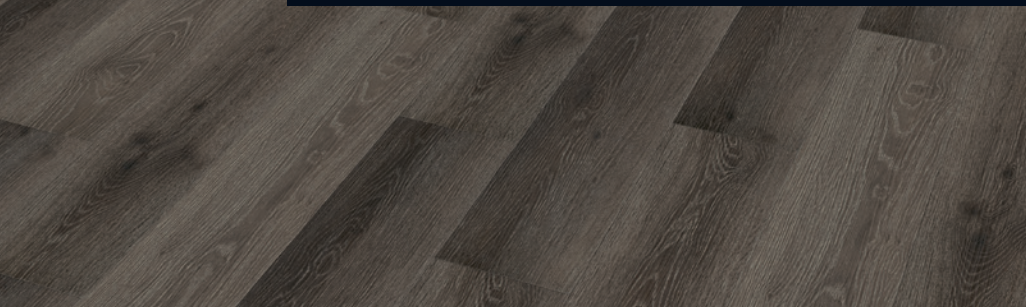

Toepassingsgebieden: 23 / 33 / 42
Toplaag: 0,55 mm
Totaal dikte: 2,5 mm
Formaat: 121,92 × 17,78 cm
Pakinhoud: 16 Planken = 3,46 m²



Toepassingsgebieden: 23 / 34
Toplaag: 0,55 mm
Totaal dikte: 5,5 mm
Formaat: 121,00 × 17,20 cm
Pakinhoud: 10 Planken = 2,08 m²



J-50019 Carrara Marble White

J-50019 / J-RCL50019 Carrara Marble White



Toepassingsgebieden: 23 / 33 / 42
 Toplaag: 0,55 mm
 Totaal dikte: 2,5 mm
 Formaat: 91,44 × 45,72 cm
 Pakinhoud: 8 Tegels = 3,34 m²



Toepassingsgebieden: 23 / 34
 Toplaag: 0,55 mm
 Totaal dikte: 5,5 mm
 Formaat: 90,00 × 45,00 cm
 Pakinhoud: 5 Tegels = 2,03 m²

J-50020 / J-RCL50020 Brazilian Graphite



Toepassingsgebieden: 23 / 33 / 42
 Toplaag: 0,55 mm
 Totaal dikte: 2,5 mm
 Formaat: 91,44 × 45,72 cm
 Pakinhoud: 8 Tegels = 3,34 m²



Toepassingsgebieden: 23 / 34
 Toplaag: 0,55 mm
 Totaal dikte: 5,5 mm
 Formaat: 90,00 × 45,00 cm
 Pakinhoud: 5 Tegels = 2,03 m²

J-50021 / J-RCL50021 Italian Terrazzo



Toepassingsgebieden: 23 / 33 / 42
Toplaag: 0,55 mm
Totaal dikte: 2,5 mm
Formaat: 91,44 × 45,72 cm
Pakinhoud: 8 Tegels = 3,34 m²



Toepassingsgebieden: 23 / 34
Toplaag: 0,55 mm
Totaal dikte: 5,5 mm
Formaat: 90,00 × 45,00 cm
Pakinhoud: 5 Tegels = 2,03 m²

DRY BACK 0,55 mm



Rigid Click+ 0,55 mm



J-50022 / J-RCL50022 Used Concrete Grey



Toepassingsgebieden: 23 / 33 / 42
Toplaag: 0,55 mm
Totaal dikte: 2,5 mm
Formaat: 91,44 × 45,72 cm
Pakinhoud: 8 Tegels = 3,34 m²



Toepassingsgebieden: 23 / 34
Toplaag: 0,55 mm
Totaal dikte: 5,5 mm
Formaat: 90,00 × 45,00 cm
Pakinhoud: 5 Tegels = 2,03 m²

J-50023 / J-RCL50023 Painted Concrete Creme



Toepassingsgebieden: 23 / 33 / 42
Toplaag: 0,55 mm
Totaal dikte: 2,5 mm
Formaat: 91,44 × 45,72 cm
Pakinhoud: 8 Tegels = 3,34 m²



Toepassingsgebieden: 23 / 34
Toplaag: 0,55 mm
Totaal dikte: 5,5 mm
Formaat: 90,00 × 45,00 cm
Pakinhoud: 5 Tegels = 2,03 m²

J-50024 / J-RCL50024 Painted Concrete Pastell



Toepassingsgebieden: 23 / 33 / 42
Toplaag: 0,55 mm
Totaal dikte: 2,5 mm
Formaat: 91,44 × 45,72 cm
Pakinhoud: 8 Tegels = 3,34 m²



Toepassingsgebieden: 23 / 34
Toplaag: 0,55 mm
Totaal dikte: 5,5 mm
Formaat: 90,00 × 45,00 cm
Pakinhoud: 5 Tegels = 2,03 m²

J-50025 / J-RCL50025 Painted Concrete Creme



Toepassingsgebieden: 23 / 33 / 42
Toplaag: 0,55 mm
Totaal dikte: 2,5 mm
Formaat: 91,44 × 45,72 cm
Pakinhoud: 8 Tegels = 3,34 m²



Toepassingsgebieden: 23 / 34
Toplaag: 0,55 mm
Totaal dikte: 5,5 mm
Formaat: 90,00 × 45,00 cm
Pakinhoud: 5 Tegels = 2,03 m²

J-50026 / J-RCL50026 Travertine Nude



Toepassingsgebieden: 23 / 33 / 42
Toplaag: 0,55 mm
Totaal dikte: 2,5 mm
Formaat: 60,96 × 30,48 cm
Pakinhoud: 20 Tegels = 3,72 m²



Toepassingsgebieden: 23 / 34
Toplaag: 0,55 mm
Totaal dikte: 5,5 mm
Formaat: 60,00 × 30,00 cm
Pakinhoud: 12 Tegels = 2,16 m²

J-50028 Florence Kitt

J-50027 / J-RCL50027 Florence Camel



Toepassingsgebieden: 23 / 33 / 42
Toplaag: 0,55 mm
Totaal dikte: 2,5 mm
Formaat: 60,96 × 30,48 cm
Pakinhoud: 20 Tegels = 3,72 m²



Toepassingsgebieden: 23 / 34
Toplaag: 0,55 mm
Totaal dikte: 5,5 mm
Formaat: 60,00 × 30,00 cm
Pakinhoud: 12 Tegels = 2,16 m²

DRY BACK 0,55 mm



Rigid Click+ 0,55 mm



J-50028 / J-RCL50028 Florence Kitt



Toepassingsgebieden: 23 / 33 / 42
Toplaag: 0,55 mm
Totaal dikte: 2,5 mm
Formaat: 60,96 × 30,48 cm
Pakinhoud: 20 Tegels = 3,72 m²



Toepassingsgebieden: 23 / 34
Toplaag: 0,55 mm
Totaal dikte: 5,5 mm
Formaat: 60,00 × 30,00 cm
Pakinhoud: 12 Tegels = 2,16 m²

J-50029 / J-RCL50029 Florence Grey



Toepassingsgebieden: 23 / 33 / 42
Toplaag: 0,55 mm
Totaal dikte: 2,5 mm
Formaat: 60,96 × 30,48 cm
Pakinhoud: 20 Tegels = 3,72 m²



Toepassingsgebieden: 23 / 34
Toplaag: 0,55 mm
Totaal dikte: 5,5 mm
Formaat: 60,00 × 30,00 cm
Pakinhoud: 12 Tegels = 2,16 m²

J-50030 / J-RCL50030 Essence Stone



Toepassingsgebieden: 23 / 33 / 42
Toplaag: 0,55 mm
Totaal dikte: 2,5 mm
Formaat: 91,44 × 91,44 cm
Pakinhoud: 8 Tegels = 3,34 m²



Toepassingsgebieden: 23 / 34
Toplaag: 0,55 mm
Totaal dikte: 5,5 mm
Formaat: 90,00 × 45,00 cm
Pakinhoud: 5 Tegels = 2,03 m²

J-50031 / J-RCL50031 Black Stone



Toepassingsgebieden: 23 / 33 / 42
Toplaag: 0,55 mm
Totaal dikte: 2,5 mm
Formaat: 91,44 × 91,44 cm
Pakinhoud: 8 Tegels = 3,34 m²



Toepassingsgebieden: 23 / 34
Toplaag: 0,55 mm
Totaal dikte: 5,5 mm
Formaat: 90,00 × 45,00 cm
Pakinhoud: 5 Tegels = 2,03 m²

EASY COMFORT · Ondervloer voor DRY BACK vloeren

De EASY COMFORT-ondervloer (2,0 mm) is een zelfklevende ondervloer en maakt leggen van een DRY BACK LVT op bestaande vloeren zoals o.a. parket mogelijk. Deze ondervloer is dus ook geschikt voor huurwoningen en andere toepassingen.

De ondervloer kan tevens op alle nieuwe vloeren worden gebruikt zolang ze egaal, droog en schoon zijn. De ondervloer die op een rol wordt geleverd, wordt met de plakant naar boven op de oude ondergrond gelegd. De nieuwe designvloer wordt daarop gelegd en moet stevig aangewalst worden. De vloer met een dikte van ca. 4,5 mm is nu gereed.

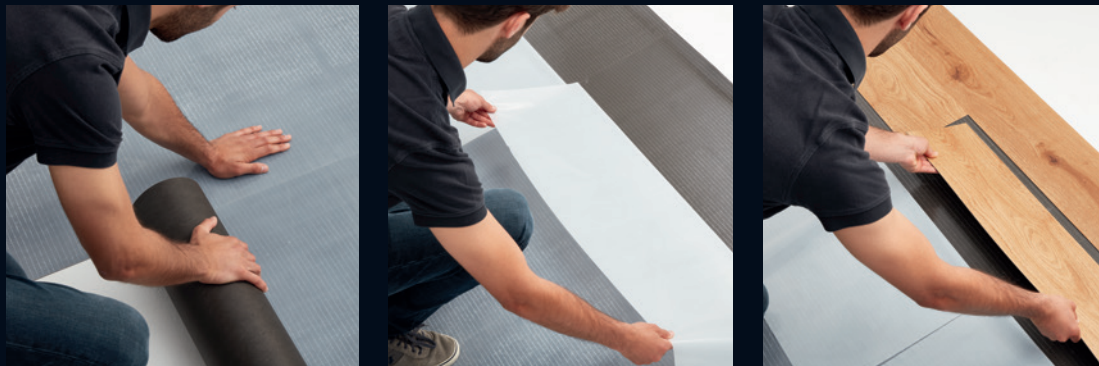

Installatie EASY COMFORT

JAB
ANSTOETZ
FLOORING

BY

BELAKOS
FLOORING

Plinten

De bijpassende plinten vormen de optimale verbinding tussen de nieuwe vloer en de wand en creëren zo de perfecte finishing touch. U kunt uw creativiteit de vrije loop laten door te kiezen tussen de moderne plint in kubusvorm in bijpassende kleur, contrasterend wit of aluminium. Speciaal voor oude gebouwen biedt de Hamburgse plint in wit een nostalgische sfeer door zijn gebogen profiel.

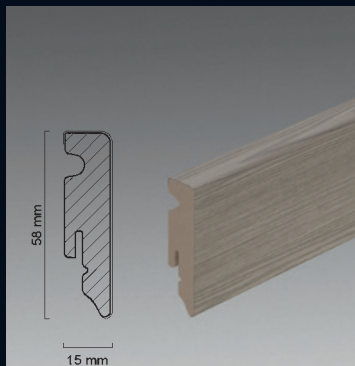

SO15/58, kubusvorm

Lengte: 2,40 m

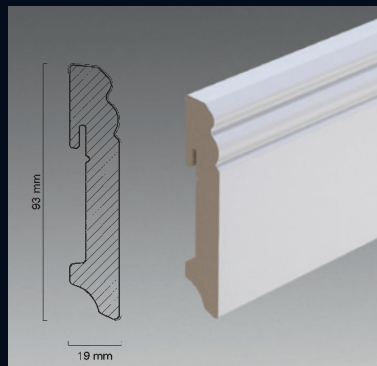

SO19/93, witte Hamburger plint

Lengte: 2,40 m

Technische gegevens



Dry Back: conform DIN EN ISO 10582

Rigid Click+: conform DIN EN 16511

Eigenschappen	Norm	Afmeting		
Dikte van de Slijtlaag	ISO 24340	mm	0,55	0,55
V-groef – Decorafhankelijk*			ja	ja
Totale dikte ca.	ISO 24346	mm	2,5	5,5
Geschikt voor rolstoel	EN 425 / ISO 4918		ja	ja
Geschikt voor vloerverwarming			ja	ja
Warmte doorlaatbaarheid ca.	EN 12667	m ² K/W	~ 0,03	~ 0,03
Warmte doorlaatbaarheid incl. ondervloer ca.		m ² K/W	–	~ 0,05
Geluidsabsorptie ca.	EN ISO 16251-1	dB	~ 4	~ 20
Loopgeluidreductie bij gebruik van de klikondervloer ca.	EN ISO 16251-1	dB	~ 4	~ 20
Brandgedrag	EN 13501-1		Bfl-s1	Bfl-s1
Lichtechtheid	EN ISO 105-B02		≥ 6	≥ 6
Antislipwaarde			R 9 / R 10	R 9 / R 10
Slipweerstand			DS	DS
Toepassingsgebieden	EN ISO 10874		23/33/42	23/34

Uitleg toepassingsgebieden



Wonen, zwaar gebruik.



Project, zwaar commercieel gebruik.



Project, bijzonder zwaar commercieel gebruik.



Industrie, algemeen licht gebruik.

* De volgende artikelen zijn niet als Rigid Click+ variant verkrijgbaar:

- J-50001 Forest Mix Nature
- J-50002 Forest Mix Creme
- J-50003 Forest Mix Grey





JAB

ANSTOETZ

FLOORING

BY

BELAKOS
FLOORING

Belakos Flooring
De Blokmat 15
NL-8281 JH Genemuiden
www.belakosflooring.com